

Light-Display: Maximale Strombelastung

Light-Display: maximum current load

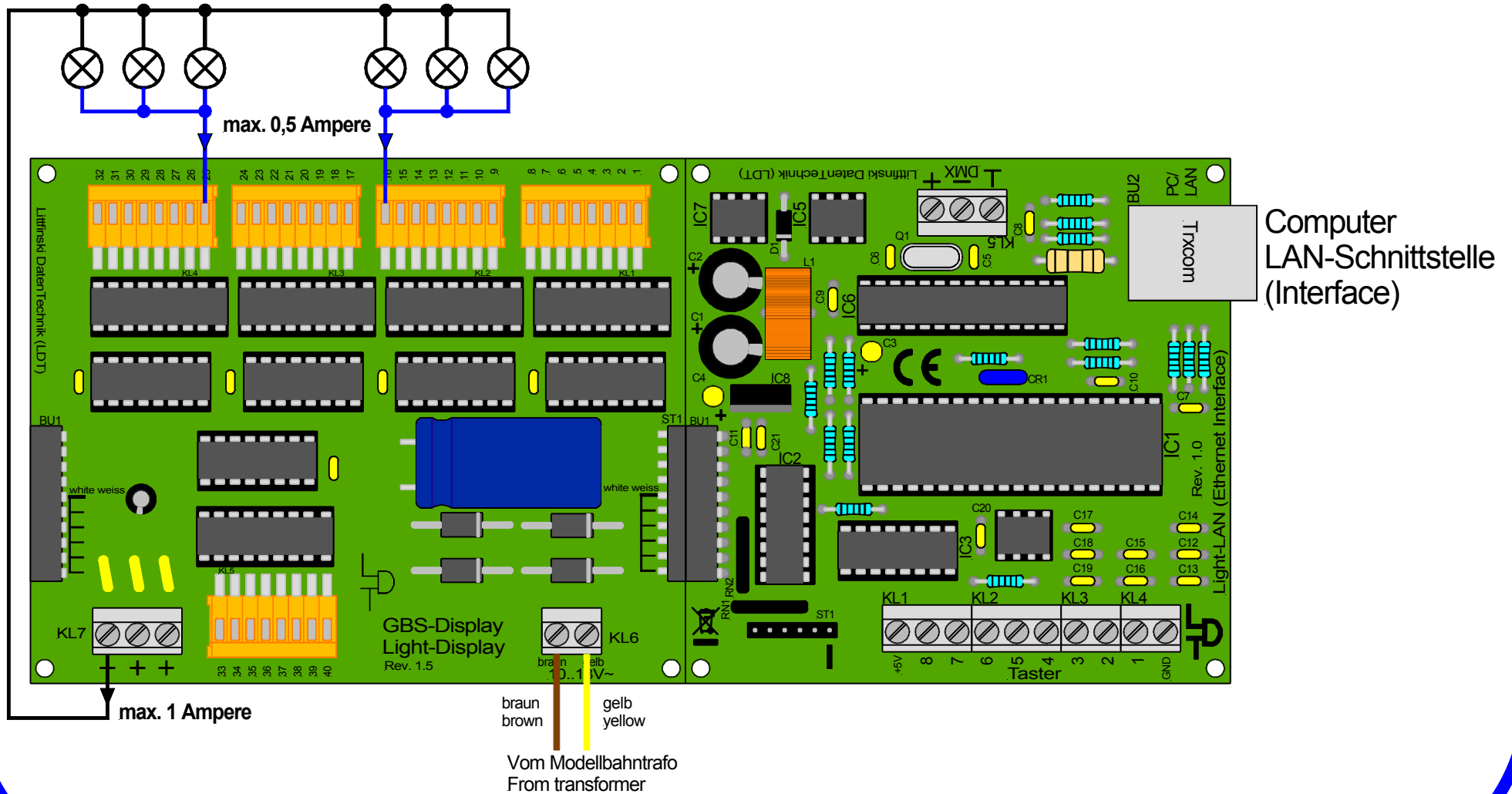

Technische Änderungen und Irrtum vorbehalten.
Subject to technical changes and errors.
© 10/2009 by LDT